

U104

R5F564MLDDFP#V1-ND

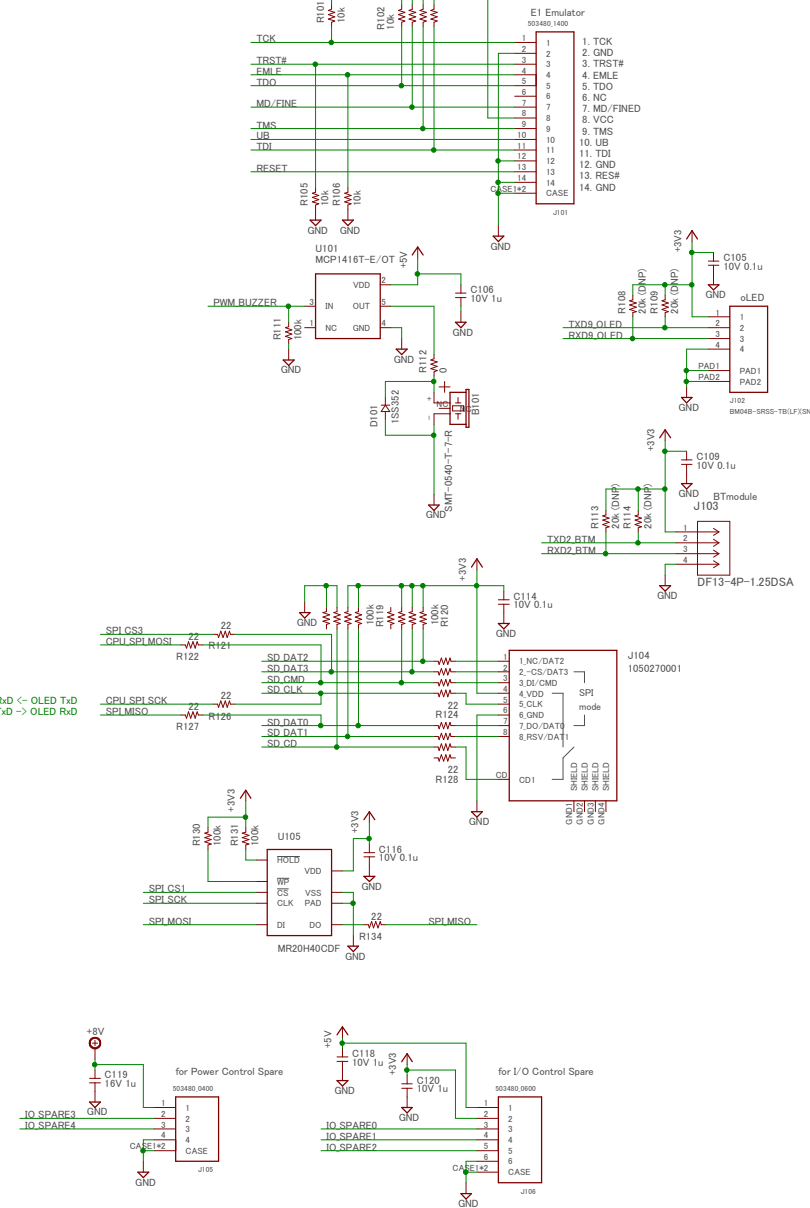
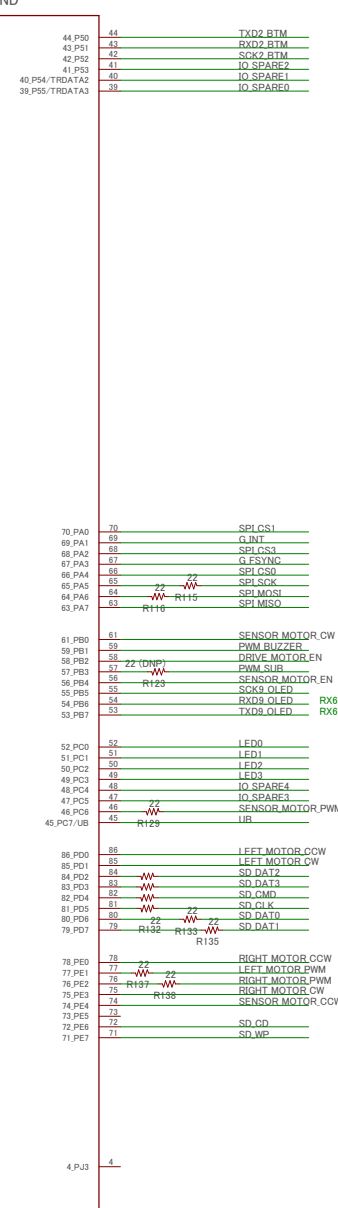
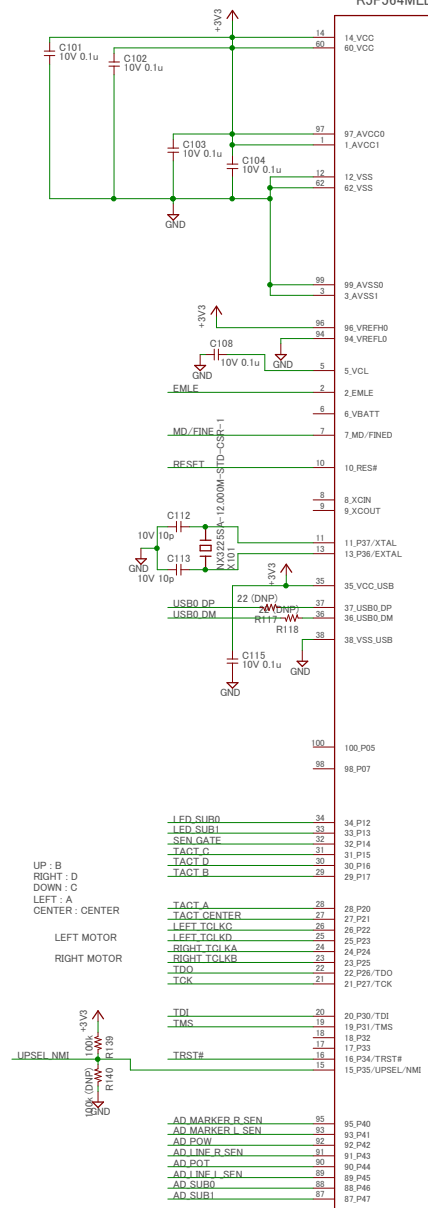
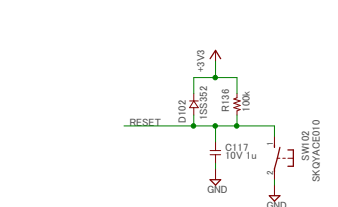
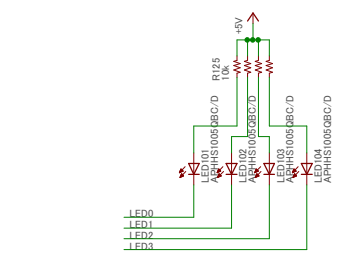
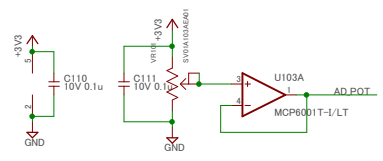
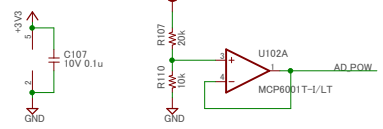
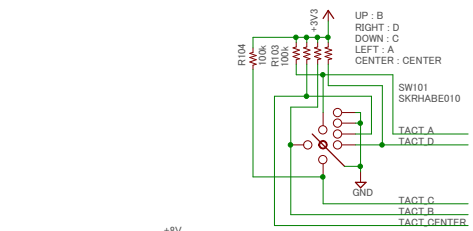

designed by S.Hirai